



*Scala*

ESTOFADOS EM COURO

CATÁLOGO

## SCALA ESTOFADOS

A SCALA ESTOFADOS é uma marca nacional, especializada na produção de sofás de couro. Estabelecidos em Arapongas, norte do estado do Paraná, estamos presente em todo o território brasileiro desde 2011.

Somos apaixonados por sofás de couro. O couro natural está no nosso DNA.

Desde o início, sempre nos dedicamos ao trabalho com couro 100% natural.

Nosso foco está essencialmente direcionado ao lojista com atendimento personalizado e em suprir as necessidades do mercado e a satisfação do consumidor com produtos fabricados com rígido controle de qualidade que proporcionem tranquilidade, conforto e segurança.

Nossa missão: Produzir e comercializar produtos que possam gerar satisfação e bem estar.

- **FOCO NO LOJISTA**

Não temos loja física

Não temos loja virtual

Não concorremos com nosso cliente oferecendo venda direta com produtos e preços abaixo do mercado

- **LINHA DIRETA COM OS RESPONSÁVEIS PELA EMPRESA**

O cliente pode falar diretamente com a diretoria da empresa quando precisar

As soluções são imediatas

Contato direto e contínuo com nossos clientes

- **ATENTOS AO MERCADO E SUAS NECESSIDADES**

Investimos em lançamentos acompanhando tecnologia e design

- **MATERIAL DE APOIO DIGITAL**

Catálogo e informações

- **REDES SOCIAIS**

INSTAGRAM - FACEBOOK

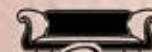

Scala

"COURO É NOSSA ESPECIALIDADE"

# COMERCIAL "A"

A - 101 PRETO



A - 102 MARROM



A - 104 TIZA



A - 105 BRANCO



A - 108 FENDI



A - 109 VERMELHO



A - 110 CONHAQUE

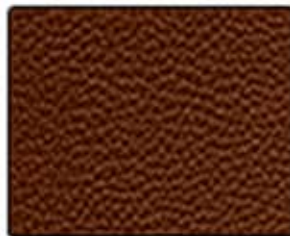

A - 112 BEGE 66



A - 114 VERDE

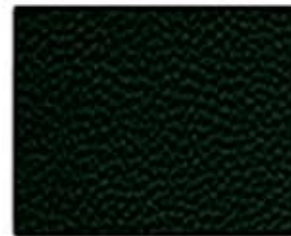

A - 115 CINZA

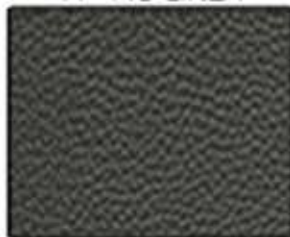

A - 116 CAPUCCINO



A - 117 BURGUNDI



A - 118 MARINHO



# STAR "B"

B - 201 SOFTLINE MEL



B - 202 SOFTLINE PRETO



B - 203 SOFTLINE CAFE - W



B - 204 SOFTLINE BEGE - M



B - 205 SOFTLINE BRANCO



B - 206 ESMERALDA



B - 207 GRAFITE



B - 208 WINE



B - 209 OLIVA



Sofá

# Aspen





Catraca



## Sofá Aspen

### Descrições Técnicas

- \*Assentos: Fixos com percintas elásticas e espumas D28
- \*Encostos: Reclináveis com espuma, opções de ângulos com catraca cromada
- \*Estrutura: Madeira de eucalipto reflorestado e tratado
- \*Revestimento: Couro 100% Natural Legítimo
- \*Pés: Metal preto
- \*Estofado Modular.

### Medidas

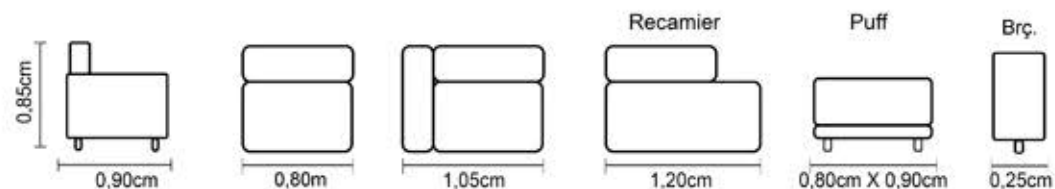

Sofá

# Ametista





## Sofá Ametista

### Descrições Técnicas

- \*Assentos: Removíveis com percintas elásticas e espumas D26
- \*Encostos: Almofadas Removíveis com fibras siliconadas
- \*Estrutura: Madeira de eucalipto reflorestado e tratado
- \*Revestimento: Couro 100% Natural Legítimo
- \*Pés: Ferro na cor preta

## Medidas

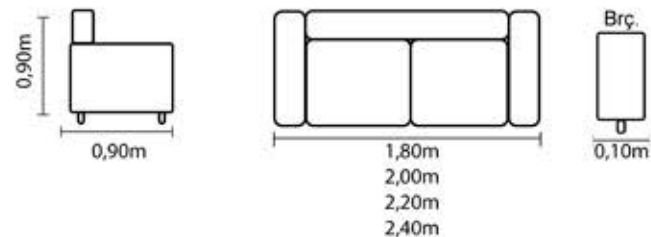

Obs. Altura assento até o chão 49cm

Sofá

# Astúria







## Sofá Astúria

### Descrições Técnicas

\*Assentos: Almofadas removíveis com percintas elásticas e espumas

\*Encostos: Mola zigzag e espumas

\*Estrutura: Madeira de eucalipto reflorestado e tratado

\*Revestimento: Couro 100% Natural Legítimo

\*Pés: Cantoneira de madeira cor imbuia.

## Medidas

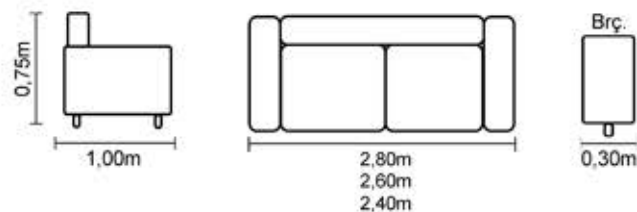

Sofá

# Bali

Fixo





## Sofá Bali

### Descrições Técnicas

- \*Assentos: Fixos com percintas elásticas e espuma
- \*Encostos: Percinta elástica, almofadas fixas com fibras siliconadas
- \*Estrutura: madeira de eucalipto reflorestado e tratado
- \*Revestimento: Couro 100% Natural Legítimo
- \*Pés: Cantoneira de madeira cor imbuia.

### Medidas

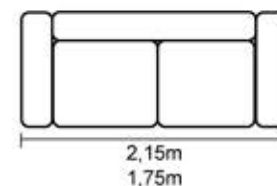
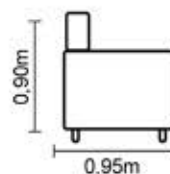

Sofá

06

# Bali retrátil





Sofá Bali retrátil

#### Descrições Técnicas

- \*Assentos: Retrátéis em aço com abertura de 60cm, percintas elásticas, espumas e molas bonnel
- \*Encostos: Percinta elástica, almofadas fixas com fibras siliconadas (acompanha almofadas extras)
- \*Estrutura: madeira de eucalipto reflorestado e tratado
- \*Revestimento: Couro 100% Natural Legítimo
- \*Pés: Bolacha de madeira na cor tabaco
- \*Estofado Bipartido.

#### Medidas

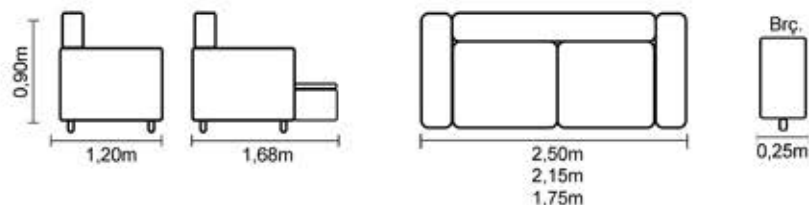

Sofá

# Barcelona retrátil





## Sofá Barcelona Retrátil

### Descrições Técnicas

- \*Assentos: Retráteis em aço com abertura de 60cm, percintas elásticas, espumas e molas bonnel
- \*Encostos: Percinta elástica, almofadas fixas com fibras siliconadas (acompanha almofadas extras)
- \*Estrutura: madeira de eucalipto reflorestado e tratado
- \*Revestimento: Couro 100% Natural Legítimo
- \*Pés: Bolacha de madeira na cor tabaco
- \*Estofado Bipartido.

## Medidas

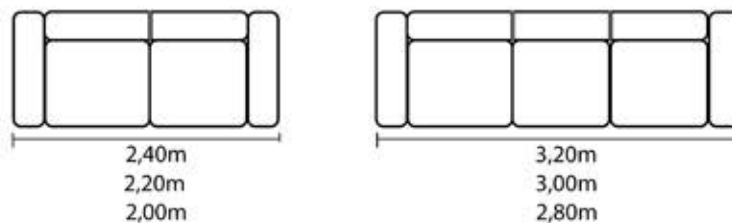
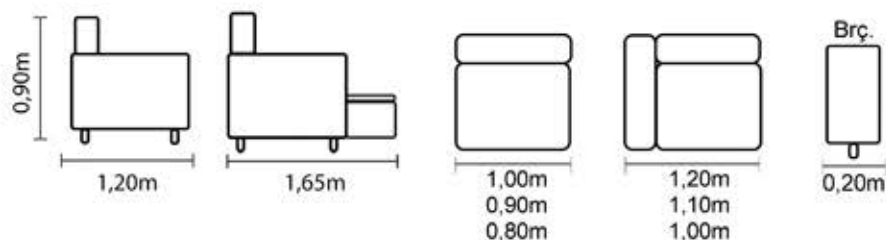

Sofá

# Benjamin







## Sofá Benjamin

### Descrições Técnicas

\*Assentos: Almofadas fixas com percintas elásticas e espumas D-28

\*Encostos: Almofadas removíveis espumas HiperSoft

\*Estrutura: Madeira de eucalipto reflorestado e tratado

\*Revestimento: Couro 100% Natural Legítimo

\*Pés: Ferro cor preto

## Medidas

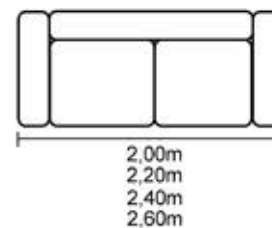
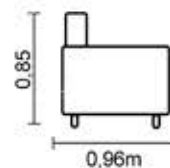

Sofá

# Bérgamo

08





### Medidas

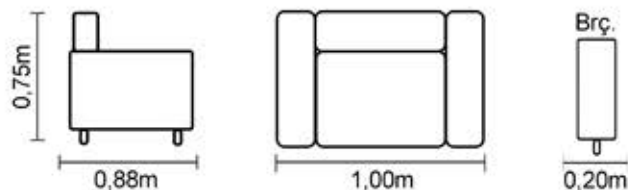

### Poltrona Bergamo

#### Descrições Técnicas

- \*Assentos: Fixos com molas zigzag e espumas
- \*Encostos: Fixos com molas zigzag e espumas
- \*Estrutura: Madeira de eucalipto reflorestado e tratado
- \*Revestimento: Couro 100% Natural Legítimo
- \*Pés: Torneado de madeira cor imbuia.

### Sofá Bergamo

#### Descrições Técnicas

- \*Assentos: Fixos com molas zigzag e espumas
- \*Encostos: Fixo com molas zigzag e espumas
- \*Estrutura: Madeira de eucalipto reflorestado e tratado
- \*Revestimento: Couro 100% Natural Legítimo
- \*Pés: Torneado de madeira cor imbuia.



### Medidas

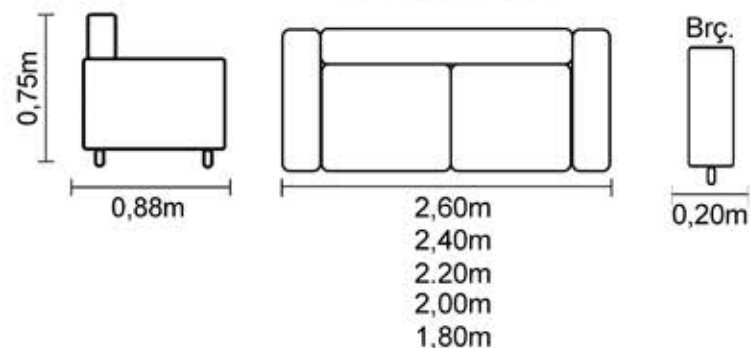

Sofá

# Concord





## Sofá Concord

### Descrições Técnicas

- \*Assentos: Fixos com percintas elásticas e espumas
- \*Encostos: Percintas Elásticas e almofadas fixas com fibra siliconada
- \*Estrutura: Madeira de eucalipto reflorestado e tratado
- \*Revestimento: Couro 100% Natural Legítimo
- \*Pés: Cantoneira de madeira cor imbuia
- \*Estofado Modular.

### Medidas

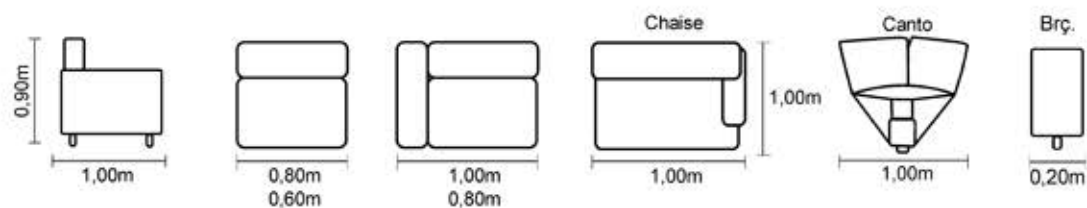

Sofá

# Copenhague





### Sofá Copenhague retrátil

#### Descrições Técnicas

\*Assentos: Retrátéis em aço com abertura de 38cm, percintas elásticas, espuma e molas bonnel

\*Encostos: Percintas elásticas e almofadas fixas com fibras siliconadas

\*Estrutura: Madeira de eucalipto reflorestado e tratado

\*Revestimento: Couro 100% Natural Legítimo

\*Pés: Cantoneira em madeira cor tabaco

\*Estofado modular.

### Medidas

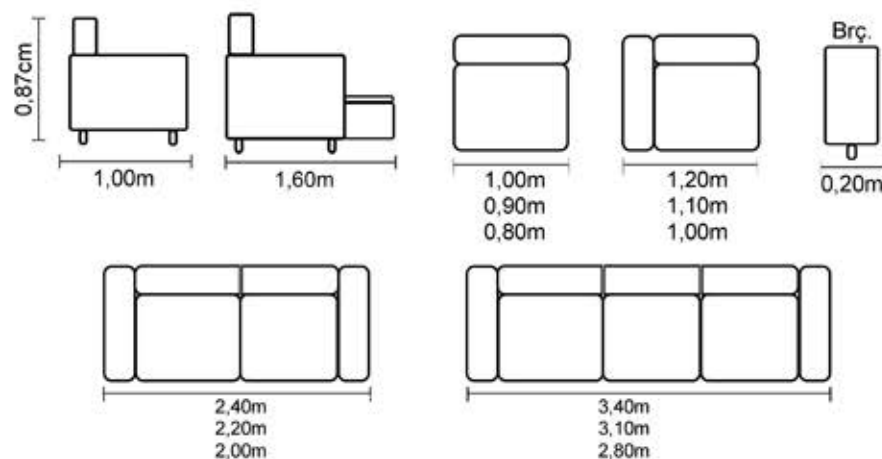

Sofá

# Dakota







## Sofá Dakota

### Descrições Técnicas

- \*Assentos: Fixos com percintas elásticas e espuma
- \*Encostos: Percintas elásticas e almofadas removíveis com fibra siliconada
- \*Estrutura: Madeira de eucalipto reflorestado e tratado
- \*Revestimento: Couro 100% Natural Legítimo
- \*Pés: Palito de madeira cor imbuia.

### Medidas

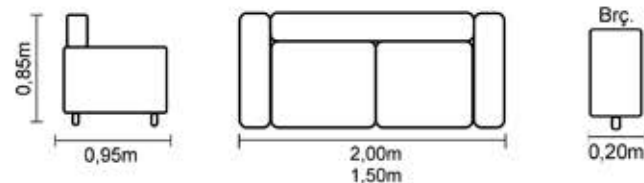

Sofá

# Dallas





## Sofá Dallas

### Descrições Técnicas

- \*Assentos: Fixos com percintas elásticas e espumas
- \*Encostos: Percintas elásticas e almofadas removíveis com fibra siliconada
- \*Estrutura: Madeira de eucalipto reflorestado e tratado
- \*Revestimento: Couro 100% Natural Legítimo
- \*Pés: Palito de madeira cor imbuia.

## Medidas

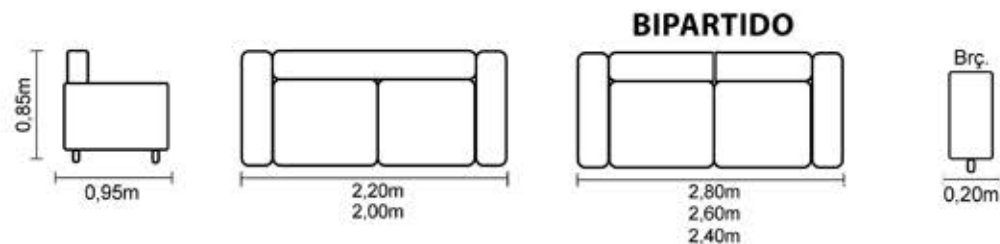

Sofá

# Dollaro

Aéreo Duplo





## Sofá Dollaro

### Descrições Técnicas

Estofado com equipamento retrátil e reclinável de acionamento elétrico, proporcionando regulação personalizada

- \*Assentos: Molas zigzag e espuma D28 Soft
- \*Encostos: Percintas elásticas e almofadas com fibras siliconadas
- \*Estrutura: Madeira de eucalipto reflorestado e tratado
- \*Revestimento: Couro 100% Natural Legítimo
- \*Pés: Cantoneira em madeira na cor imbuia.

## Medidas

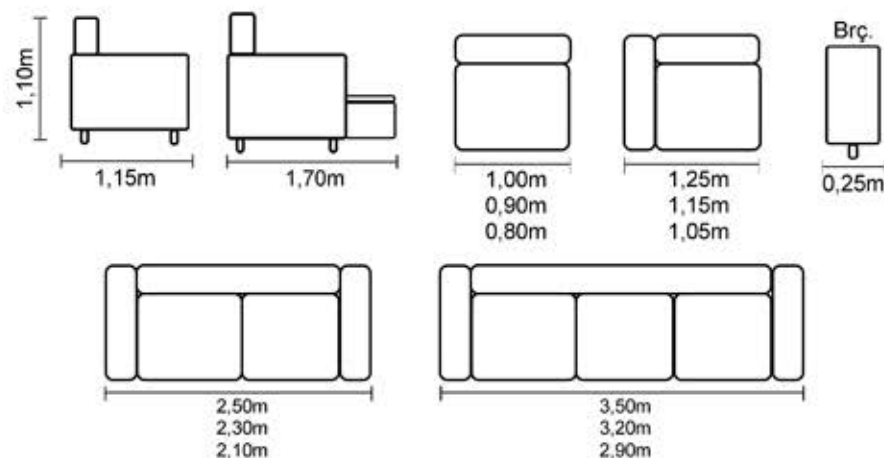



## Sofá Dublin

### Descrições Técnicas

- \*Assentos: Fixos com molas zigzag e espumas D28
- \*Encostos: Percintas elásticas e almofadas fixas com fibra siliconada
- \*Estrutura: Madeira de eucalipto reflorestado e tratado
- \*Revestimento: Couro 100% Natural Legítimo
- \*Pés: Metal tingido cor café.

### Medidas

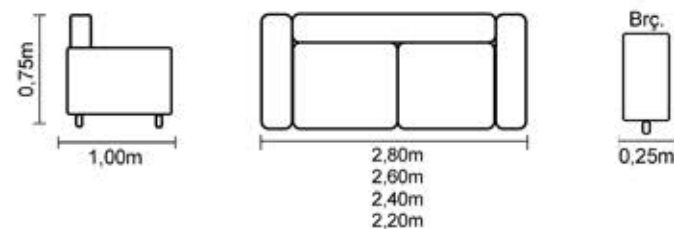

Sofá

# Dublin



Sofá

# Filadélfia







## Medidas

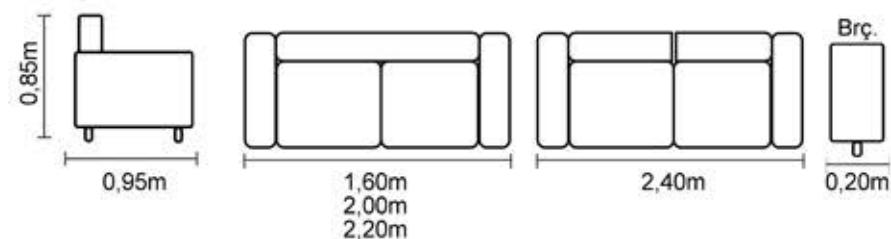

### Sofá Filadélfia

#### Descrições Técnicas

- \*Assentos: Fixos com espumas D26
- \*Encostos: Composto com fibra siliconada
- \*Estrutura: Madeira de eucalipto reflorestado e tratado
- \*Revestimento: Couro 100% Natural Legítimo
- \*Pés: Madeira imbuia

Sofá

# Florença





## Sofá Florença

### Descrições Técnicas

- \*Assentos: Almofadas fixas com molas zigzag e espumas D-28 macia
- \*Encostos: Percintas elásticas com almofadas removíveis fibras siliconadas
- \*Estrutura: Madeira de eucalipto reflorestado e tratado
- \*Revestimento: Couro 100% Natural Legítimo
- \*Pés: Madeira cor imbuia

### Medidas

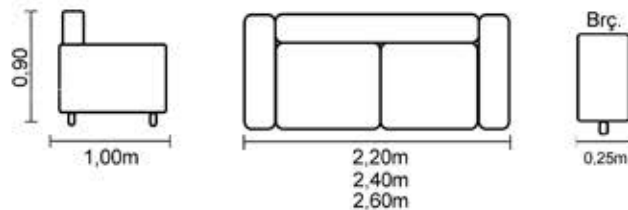

Sofá

# Lisboa



**Aberto****Fechado**

## Sofá Lisboa retrátil

## Descrições Técnicas

- \*Assentos: Mecanismo retrátil manual com abertura de 60cm, percintas elásticas, espuma e molas bonnel
- \*Encostos: Percintas elásticas e almofadas fixas com fibras siliconadas; mecanismo manual para reclinar em estágios
- \*Estrutura: Madeira de eucalipto reflorestado e tratado
- \*Revestimento: Couro 100% Natural Legítimo
- \*Pés: Cantoneira em madeira na cor imbuia.

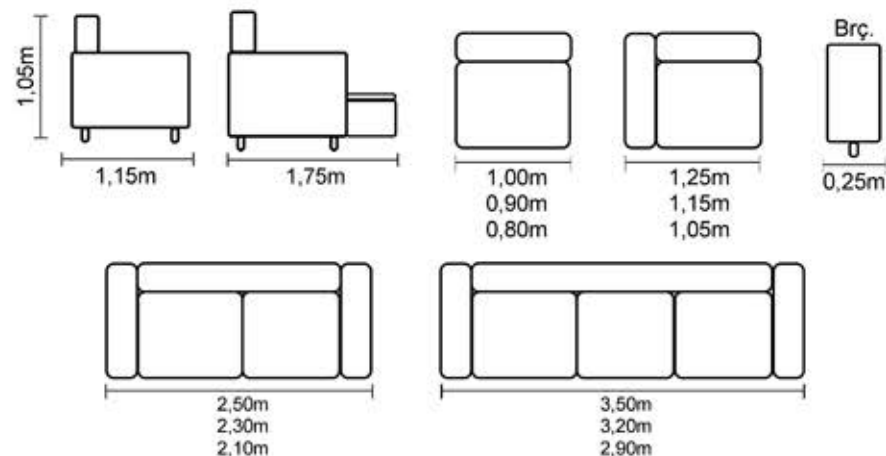
**Medidas**

Sofá

# Malta

24





## Sofá Malta

### Descrições Técnicas

- \*Assentos: Fixos com molas e espuma
- \*Encostos: Percinta elástica, almofadas removíveis com fibras siliconadas
- \*Estrutura: madeira de eucalipto reflorestado e tratado
- \*Revestimento: Couro 100% Natural Legítimo
- \*Pés: Metal Tingido cor café

### Medidas

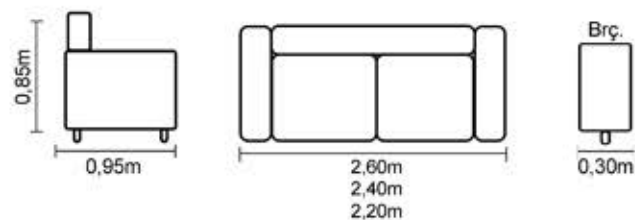

Sofá

# Malibu







Sofá Malibu

#### Descrições Técnicas

- \*Assentos: Fixos com percintas elásticas e espuma
- \*Encostos: Percintas elásticas e almofadas removíveis com fibra siliconada
- \*Estrutura: Madeira de eucalipto reflorestado e tratado
- \*Revestimento: Couro 100% Natural Legítimo
- \*Pés: Palito de madeira cor imbuia
- \*Detalhe lateral com fivela opcional com cores A110 conhaque e A112 bege 66.

#### Medidas

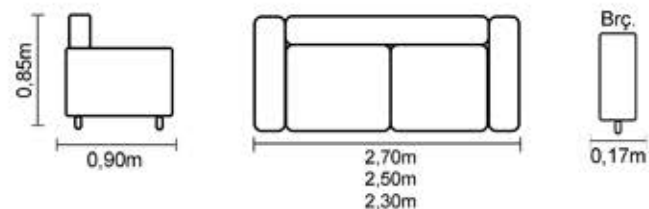

Sofá

# Milano

Fixo





## Sofá Milano

### Descrições Técnicas

- \*Assentos: Fixos com percintas elásticas e espuma
- \*Encostos: Percintas elásticas e almofadas fixas com fibras siliconadas
- \*Estrutura: Madeira de eucalipto reflorestado e tratado
- \*Revestimento: Couro 100% Natural Legítimo
- \*Pés: Cantoneira em madeira cor imbuia.

### Medidas

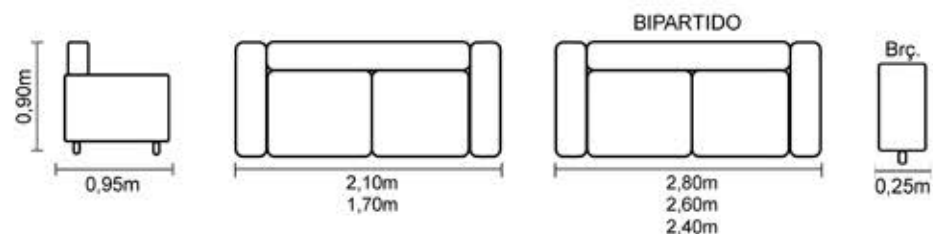

Sofá

# Milano retrátil





Sofá Milano retrátil

#### Descrições Técnicas

\*Assentos: Retrátéis em aço com abertura de 40cm, percintas elásticas, espuma e molas bonnel

\*Encostos: Percintas elásticas e almofadas fixas com fibras siliconadas

\*Estrutura: Madeira de eucalipto reflorestado e tratado

\*Revestimento: Couro 100% Natural Legítimo

\*Pés: Cantoneira em madeira cor imbuia

\*Estofado bipartido à partir de 2,40m.

#### Medidas

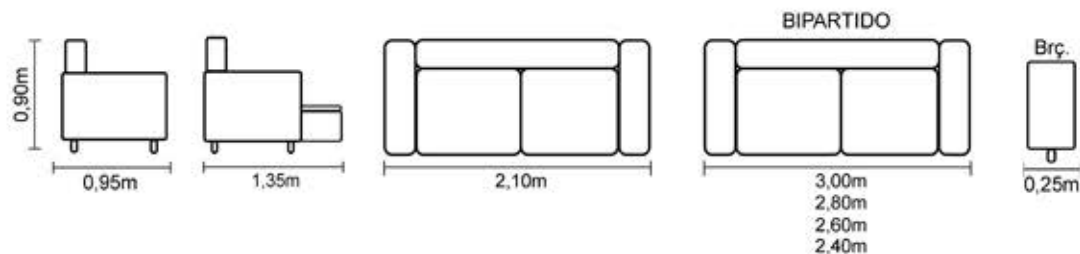

Sofá

# Parma





## Sofá Parma

### Descrições Técnicas

\*Assentos: Almofadas fixas com molas nozag e espumas

\*Encostos: Fixos com espumas

\*Estrutura: Madeira de eucalipto reflorestado e tratado

\*Revestimento: Couro 100% Natural Legítimo

\*Pés: Base em Madeira

## Medidas

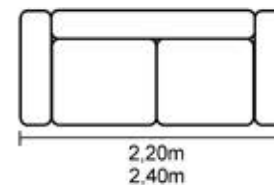
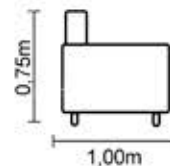

Sofá

# Ravena







Sofá Ravena

#### Descrições Técnicas

- \*Assentos: Fixos com molas zigzag e espumas
- \*Encostos: Fixos com molas zigzag e espumas
- \*Estrutura: Madeira de eucalipto reflorestado e tratado
- \*Revestimento: Couro 100% Natural Legítimo
- \*Pés: Torneado de madeira cor imbuia.

#### Medidas

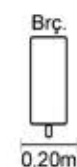
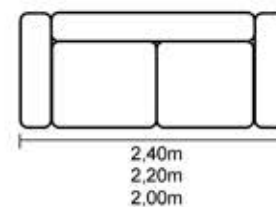
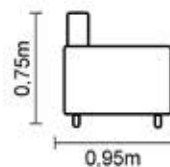

Sofá

# Roma





## Sofá Roma

### Descrições Técnicas

- \*Assentos: Fixos com percintas elásticas e espuma
- \*Encostos: Percintas elásticas, almofadas fixas com fibras siliconadas
- \*Estrutura: madeira de eucalipto reflorestado e tratado
- \*Revestimento: Couro 100% Natural Legítimo
- \*Pés: Cantoneira em madeira cor imbuia.

### Medidas

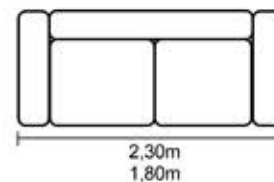
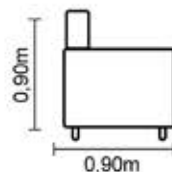

Sofá

# Topázio





## Medidas

### Sofá e Poltrona Topázio

#### Descrições Técnicas

- \*Assentos: Molas zigzag e espumas D28 Soft
- \*Encostos: Almofadas removíveis com fibra siliconada
- \*Estrutura: Madeira de eucalipto reflorestado e tratado
- \*Revestimento: Couro 100% Natural Legítimo
- \*Pés: Bolacha de madeira na cor tabaco.

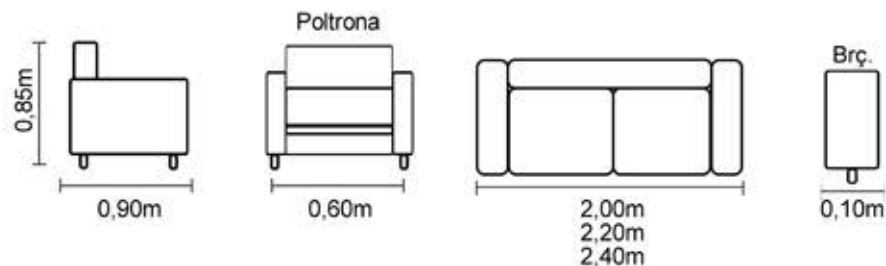

Sofá

# San Diego





Sofá San Diego

#### Descrições Técnicas

- \*Assentos: Fixos com percintas elásticas e espumas
- \*Encostos: Percintas Elásticas e almofadas fixas com fibra siliconada
- \*Estrutura: Madeira de eucalipto reflorestado e tratado
- \*Revestimento: Couro 100% Natural Legítimo
- \*Pés: Cantoneira de madeira cor imbuia
- \*Estofado Modular.

#### Medidas

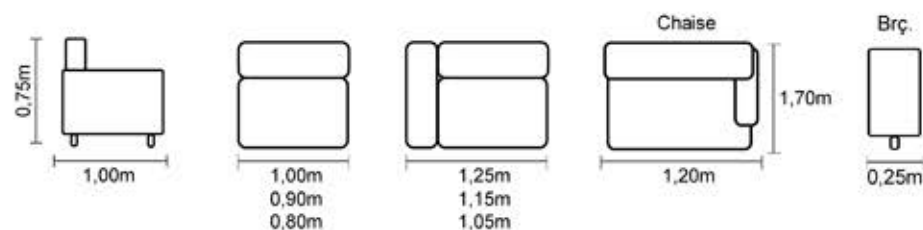

Sofá

# Turim

38







## Sofá Turim

### Descrições Técnicas

- \*Assentos: Fixos com percintas elásticas e espuma
- \*Encostos: Percinta elástica e almofadas fixas com fibras siliconadas
- \*Estrutura: madeira de eucalipto reflorestado e tratado
- \*Revestimento: Couro 100% Natural Legítimo
- \*Pés: Cantoneira em madeira na cor imbuia.

### Medidas

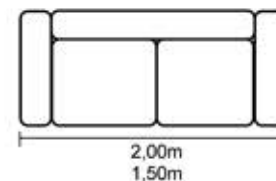
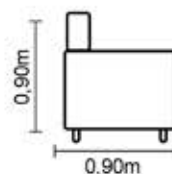

Sofá

Venezuela





Sofá Veneza

#### Descrições Técnicas

- \*Assentos: Fixos com percintas elásticas e espuma
- \*Encostos e braços: Percinta elástica, almofadas fixas com fibras siliconadas
- \*Estrutura: madeira de eucalipto reflorestado e tratado
- \*Revestimento: Couro 100% Natural Legítimo
- \*Pés: Bolacha em madeira na cor tabaco

#### Medidas

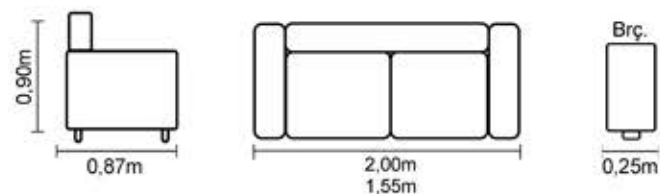

Poltrona

# Amanda

42





Opção de Pés



Poltrona Amanda

#### Descrições Técnicas

- \*Assentos: Removíveis com percintas elásticas e espumas
- \*Encostos: Percintas elásticas e espumas
- \*Estrutura: Madeira de eucalipto reflorestado e tratado
- \*Revestimento: Couro 100% Natural Legítimo
- \*Pés: Rodízio de latão príncipe na cor dourado e também em madeira.

#### Medidas

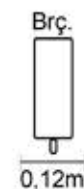
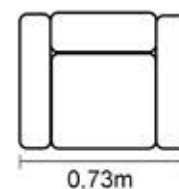
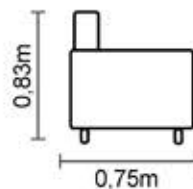

Poltrona

# Antonella





Poltrona Antonella

#### Descrições Técnicas

Poltrona com equipamento retrátil e reclinável de acionamento elétrico, proporcionando regulagem personalizada.

\*Assentos: Percintas elásticas, molas zigzag e espumas D28 Soft

\*Encostos: Percintas elásticas e almofadas com fibra siliconada

\*Estrutura: Madeira de eucalipto reflorestado e tratado

\*Revestimento: Couro 100% Natural Legítimo

\*Pés: Bolacha de madeira na cor tabaco.

#### Medidas

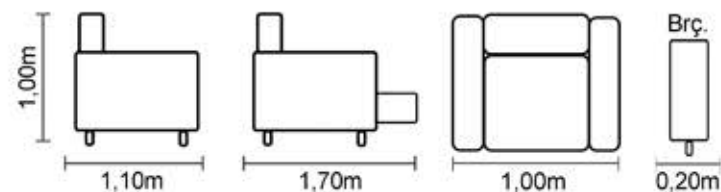

Poltrona

# Ellus

46







Poltrona Ellus

#### Descrições Técnicas

- \*Assentos: Fixos com percintas elásticas e espumas
- \*Encostos: Percintas elásticas e espumas, acompanha almofada com fibra siliconada
- \*Estrutura: Madeira de eucalipto reflorestado e tratado
- \*Revestimento: Couro 100% Natural Legítimo
- \*Pés: Metal tingido na cor preta.

#### Medidas

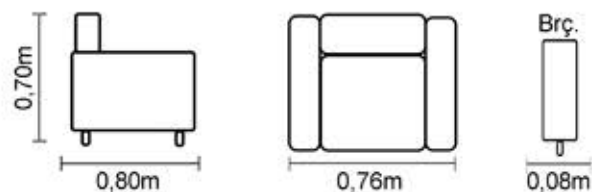

Poltrona

# Luiza

48





Poltrona Luiza

#### Descrições Técnicas

- \*Assentos: Removíveis com percintas elásticas e espumas
- \*Encostos: Percintas elásticas e espumas
- \*Estrutura: Madeira de eucalipto reflorestado e tratado
- \*Revestimento: Couro 100% Natural Legítimo
- \*Pés: Torneado em madeira na cor imbuia e também rodízio príncipe.

#### Medidas

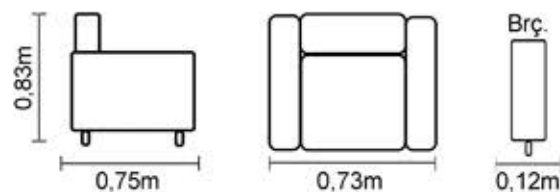

Opção de Pés

# Agnes



## Descrições Técnicas

- \*Assentos: Fixos com percintas elásticas e espumas
- \*Encostos: Fixos e espumas
- \*Estrutura: Madeira de eucalipto reflorestado e tratado
- \*Revestimento: Couro 100% Natural Legítimo
- \*Pés: Metal, tingido na cor preta.

## Medidas

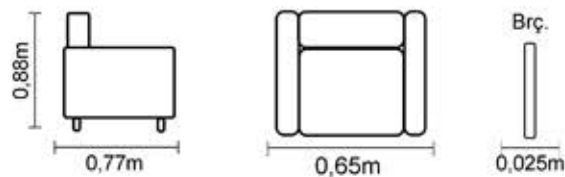

# Dallas



## Descrições Técnicas

- \*Assentos: Fixos com percintas elásticas e espumas
- \*Encostos: Removíveis com fibras siliconadas, percintas elásticas e espumas
- \*Estrutura: Madeira de eucalipto reflorestado e tratado
- \*Revestimento: Couro 100% Natural Legítimo
- \*Pés: Base em metal tingido na cor preta.

## Medidas

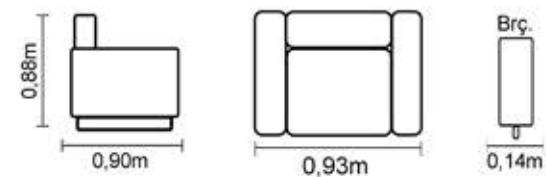

# Alícia



## Descrições Técnicas

- \*Assentos: Fixos com percintas elásticas e espumas
- \*Encostos: Percintas elásticas e almofadas removíveis com fibra siliconada
- \*Estrutura: Madeira de eucalipto reflorestado e tratado
- \*Revestimento: Couro 100% Natural Legítimo
- \*Pés: Palito em madeira cor imbuia.

## Medidas

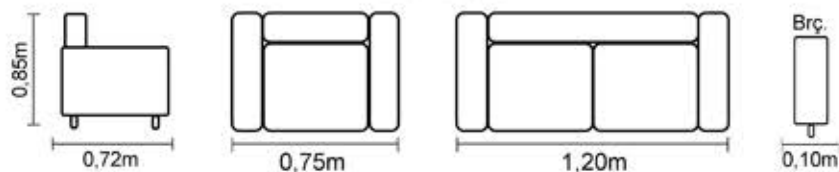

# Noah



## Descrições Técnicas

- \*Assentos: Fixos com percintas elásticas e espumas
- \*Encostos: Percintas elásticas e espumas
- \*Estrutura: Madeira de eucalipto reflorestado e tratado
- \*Revestimento: Couro 100% Natural Legítimo
- \*Pés: Madeira na cor imbuia.

## Medidas

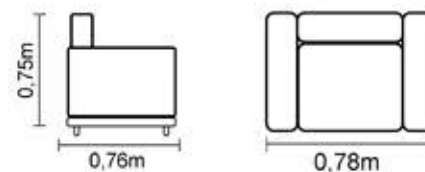

Poltrona  
**Bia**



Descrições Técnicas

- \*Assentos: Fixos com percintas elásticas e espumas
- \*Encostos: Fixos e espumas
- \*Estrutura: Madeira de eucalipto reflorestado e tratado
- \*Revestimento: Couro 100% Natural Legítimo
- \*Pés: Palito na cor imbuia.

**Medidas**

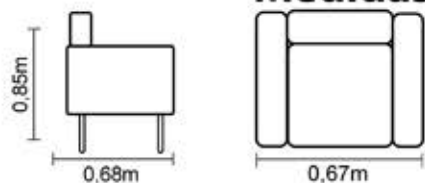

Poltrona  
**Isis**



Descrições Técnicas

- \*Assentos: Fixos com percintas elásticas e espumas
- \*Encostos: Fixos e espumas
- \*Estrutura: Madeira de eucalipto reflorestado e tratado
- \*Revestimento: Couro 100% Natural Legítimo
- \*Pés: Base em metal tingido na cor preta.

**Medidas**

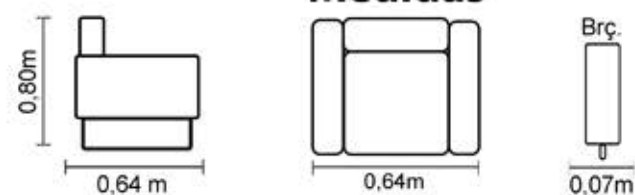

Poltrona  
**Bella**



Descrições Técnicas

- \*Assentos: Fixos com percintas elásticas e espumas
- \*Encostos: Percintas elásticas e espumas
- \*Estrutura: Madeira de eucalipto reflorestado e tratado
- \*Revestimento: Couro 100% Natural Legítimo
- \*Pés: Palito de madeira.

**Medidas**

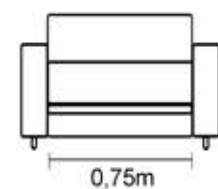
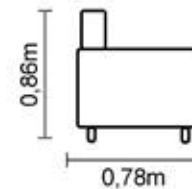

Puff

53

# Bergamo







Puff Bergamo

#### Descrições Técnicas

\*Assentos: Fixos capitonados com percintas elásticas e espumas

\*Estrutura: Madeira de eucalipto reflorestado e tratado

\*Revestimento: Couro 100% Natural Legítimo

\*Pés: Torneado de madeira na cor imbuia.

#### Medidas

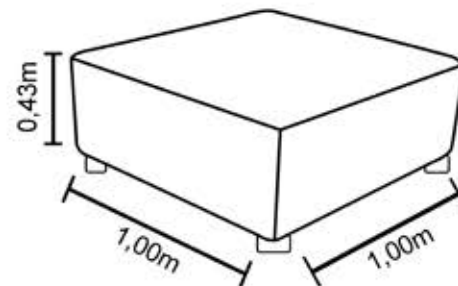

Puff

# Milano



## Descrições Técnicas

- \*Assentos: Fixos com percintas elásticas e espumas
- \*Estrutura: Madeira de eucalipto reflorestado e tratado
- \*Revestimento: Couro 100% Natural Legítimo
- \*Pés: Cantoneira de madeira na cor imbuia.

## Medidas

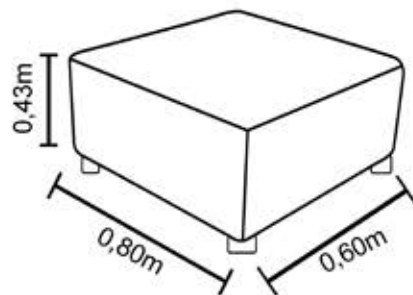
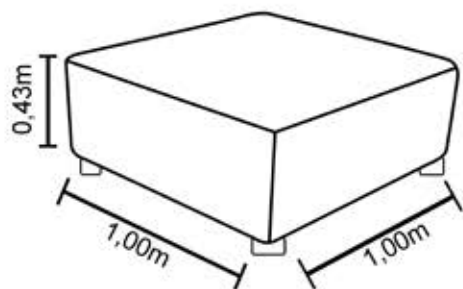

Puff

# Quebec



## Descrições Técnicas

- \* Assento: fixos, percintas elásticas e espuma
- \* Estrutura: madeira de eucalipto reflorestado e tratado
- \* Revestimento: couro 100% natural legítimo
- \* Sapata em plástico preto.

## Medidas

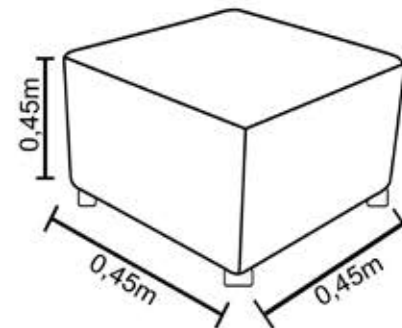

## Dijon



## Descrições Técnicas

\*Assentos: Espumas

\*Estrutura: Madeira de eucalipto reflorestado e tratado

\*Revestimento: Couro 100% Natural Legítimo

\*Pés: Aramado em metal tingido cor café, também na opção palito em madeira na cor imbuia.

## Medidas

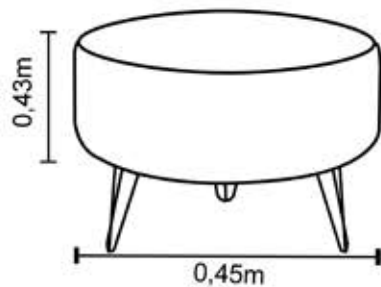

## Bora



## Descrições Técnicas

\*Assentos: Espumas

\*Estrutura: Madeira de eucalipto reflorestado e tratado

\*Revestimento: Couro 100% Natural Legítimo

\*Pés: Madeira na cor imbuia.

## Medidas

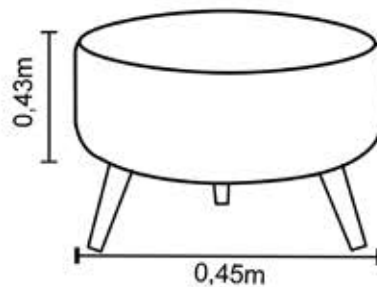

## Medidas

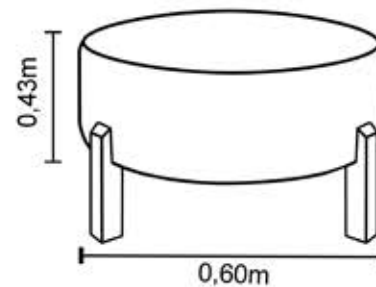

Recamier

# Verona





## Recamier Verona

### Descrições Técnicas

- \*Assentos: Fixos com percintas elásticas e espumas
- \*Estrutura: Madeira de eucalipto reflorestado e tratado
- \*Revestimento: Couro 100% Natural Legítimo
- \*Pés: Madeira na cor imbuia.

## Medidas

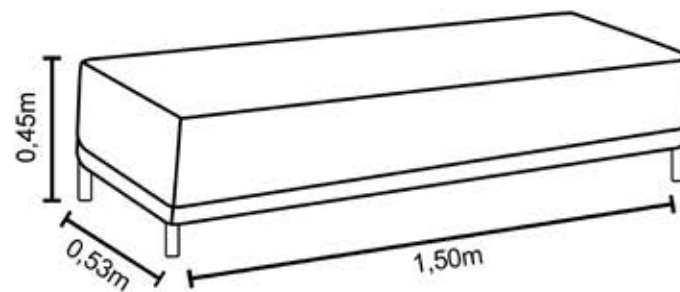



**ESTOFADOS EM COURO**

*"COURO É NOSSA ESPECIALIDADE"*



## ESTOFADOS EM COURO

*R. Rouxinol, 5910 - Parque Industrial IV,  
Arapongas - PR, 86706-418*

 [scalaestofados](#)

 [@scalaestofados](#)

 043 3274-4140

 043 98864-2477 - comercial

 [comercial@scalaestofados.com.br](mailto:comercial@scalaestofados.com.br)